



Mietpreise

Mini- und Kompaktbagger

	E10	E17	E19	E27	E50	E62	E85
Einsatzgewicht	1,2t	1,7t	1,9t	2,7t	5,0t	6,0t	8,5t
Grabtiefe (m)	1,8	2,25	2,4	3,0	3,9	4,0	4,2
Breite (m)	0,7-1,1	1-1,3	1-1,3	1,5	2,0	2,0	2,4

Tagespreis

1-5 Miettage	80€	Sonderpreis!	80€	120€	160€	170€	180€
6-20 Miettage	60€	50€ *	60€	100€	140€	150€	160€
ab 20 Miettagen	40€		40€	80€	110€	120€	130€

* inkl. Versicherung

PKW Anhänger: 10 €/Tag
(nur in Verbindung mit Mietgerät)



Mietpreise

Mobilbagger

Einsatzgewicht	12 t
Grabtiefe (m)	4,4
Breite (m)	2,5

Tagespreis

1-5 Miettage	230€
6-20 Miettage	200€
ab 20 Miettagen	160€



Anbaugeräte



Hydraulikhämmer

Trägergerät	1-2t	2-5t	6-12t
1-5 Miettage	80€	100€	120€
6-20 Miettage	60€	80€	100€
ab 20 Miettagen	40€	60€	80€



Sortiergreifer

Trägergerät	5/6t	8,5t - 12t
1-5 Miettage	100€	120€
6-20 Miettage	80€	100€
ab 20 Miettagen	60€	80€



Zweischalengreifer

Trägergerät	2-5t
1-5 Miettage	30€
6-20 Miettage	20€
ab 20 Miettagen	15€



Erdborner

Trägergerät	2-6t
1-5 Miettage	80€
6-20 Miettage	60€
ab 20 Miettagen	30€

Alle technischen Angaben sind gerundet. Maschinenversicherung: 10% des Mietpreises/Kalendertag.
Alle Preise verstehen sich zzgl. Kraftstoff, Maschinenversicherung, Transport und 19% MwSt.





Mietpreise					
Kettenbagger		Ausstattung		Ausstattung	
Einsatzgewicht	18 t	Oilquick OQ60-50	24t	Oilquick OQ70-55	
Grabtiefe (m)	5,5	Verstellausleger	6,7	Verstellausleger	
Breite (m)	2,5	Roadlinder Ketten	3,0		
		Planierschild			
Tagespreis					
1-5 Miettage	250€		300€		
6-20 Miettage	200€		250€		
ab 20 Miettagen	180€		200€		

Anbaugeräte

Abbruch/Sortiergreifer



Sieblöffel

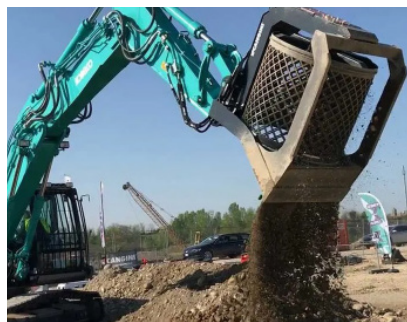

Abbruchzange

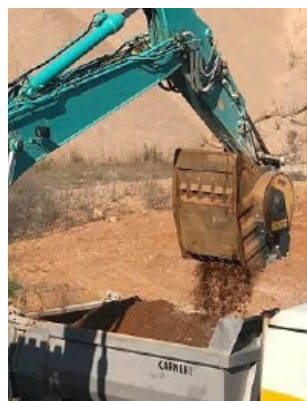
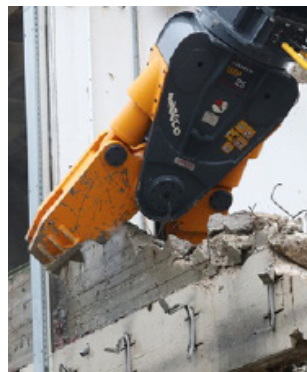

Hydraulikmagnet



Brecherlöffel



Hydraulikhammer



	Sortiergreifer		Hydraulikhammer		Abbruchzange	Hydraulikmagnet	Sieblöffel	Brecherlöffel
Tagespreis	18t	24t	18t	24t	24t	24t	24t	24t
1-5 Tage	150€	180€	150€	200€	250€	150€	200€	300€
6-20 Tage	120€	130€	120€	150€	200€	120€	150€	270€
ab 20 Tage	100€	110€	100€	120€	150€	100€	120€	230€



TL 70 (Schwenklader)



TL 80

Mietpreise

	TL 70	TL 80	TL 100	TL120
Einsatzgewicht	5,4t	4,9t	5,7t	7,0t
Schaufelvolumen (m ³)	0,7m ²	0,8	1,0	1,2
Breite (m)	1,85	1,8	1,9	2,0
Hubkraft (t)	2,0	2,5	3,2	3,5

Tagespreis

1–5 Miettage	120€	120€	140€	150€
6–20 Miettage	100€	100€	120€	130€
ab 20 Miettagen	80€	80€	100€	110€

Schaufeln und Palettengabeln sind im Mietpreis enthalten.



TL 100



TL 120

Alle technischen Angaben sind gerundet. Maschinenversicherung: 10% des Mietpreises/Kalendertag.
Alle Preise verstehen sich zzgl. Kraftstoff, Maschinenversicherung, Transport und 19% MwSt.





Bobcat



Bobcat T870

Gewicht: 5,9t
 Breite: 2,1 m
 Schaufelvolumen: 0,5–0,8m²
 Fahrbare Nutzlast: 1,8t
 Kippplast: 4,9t
 Geschwindigkeit: 18 km/h

Mietpreise

1–5 Tage: 200 € / Tag
 6–20 Tage: 170 € / Tag
 ab 20 Tage: 150 € / Tag

zzgl. Maschinenversicherung 10%/Tag
 und zzgl. 19% MwSt.



Auch mit Fernbedienung!



Kompatible Anbaugeräte in der Übersicht

Anbaugeräte	Standardschaufel	Palettengabel	Niederhalteschaufel	Erdbohrer	Hydraulikhammer	Laser Planierschild
Tagespreis						
1–5 Tage	0	0	30	60	100	200
6–20 Tage	0	0	20	40	80	150
ab 20 Tage	0	0	10	20	60	120

Preise zzgl. 19% MwSt

2-Richtungs Laser Planierschild
 für Bobcat Raupen T770 + T870



Spectra 2D Laser GL 422N inkl. Zubehör



Mietpreise

1–5 Tage: 100 € / Tag
 6–20 Tage: 80 € / Tag
 ab 20 Tage: 50 € / Tag

zzgl. 19% MwSt.

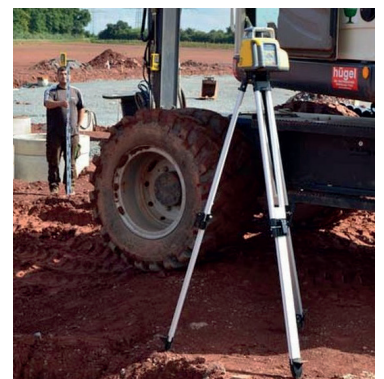

MANITOU

Teleskopplader



MT 1440

Hubkraft: 4 t

Reichweite: 14 m

Schaufelinhalt: 1,2–3m³

Mietpreise

1–5 Tage: 200 € / Tag

6–20 Tage: 150 € / Tag

ab 20 Tage: 120 € / Tag

zzgl. Maschinenversicherung 10%/Tag
und zzgl. 19% MwSt.



Anbaugeräte Teleskopplader

	Arbeitsbühne	Seilwinde
1–5 Miettage	60 €	60 €
6–20 Miettage	40 €	40 €
ab 20 Miettagen	20 €	20 €

Standard-Anbaugeräte wie Schaufel, Gabel
oder Gittermast sind im Mietpreis enthalten

MRT 2150

Hubkraft: 5 t

Reichweite: 21 m

Inkl. Funk-Fernbedienung

Mietpreise

1–5 Tage: 300 € / Tag

6–20 Tage: 250 € / Tag

ab 20 Tage: 200 € / Tag

zzgl. Maschinenversicherung 10%/Tag
und zzgl. 19% MwSt.



Lastdiagramm MT1440

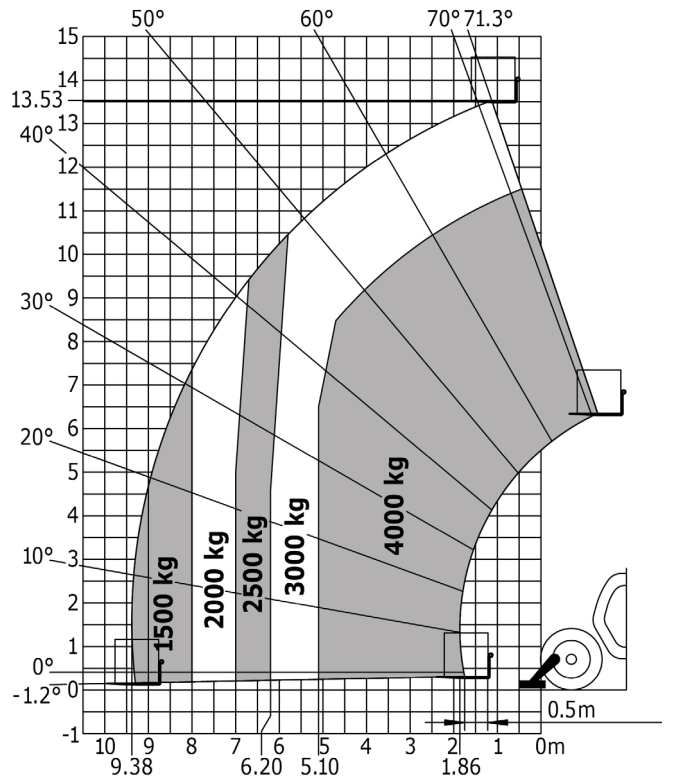
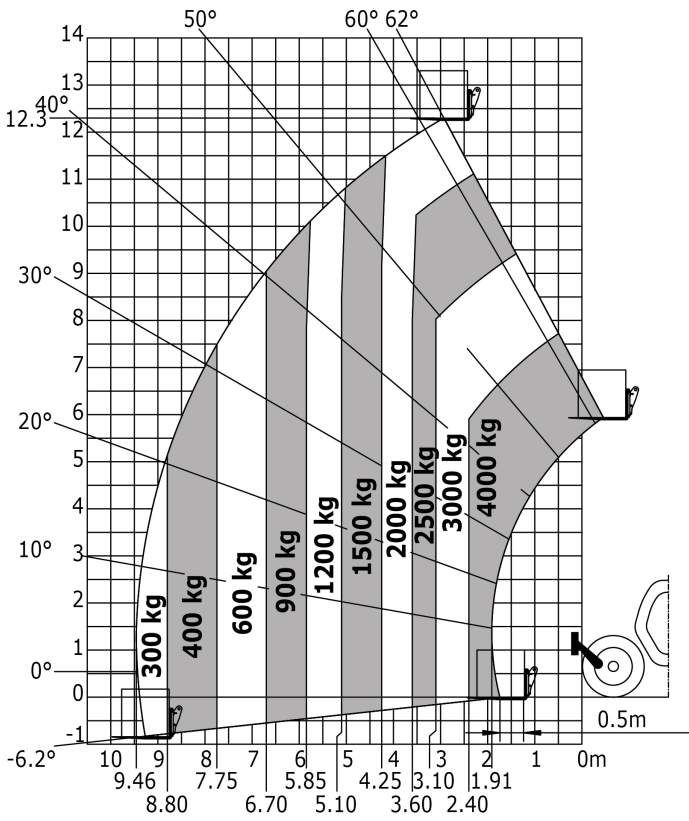

Lastdiagramm MRT2150

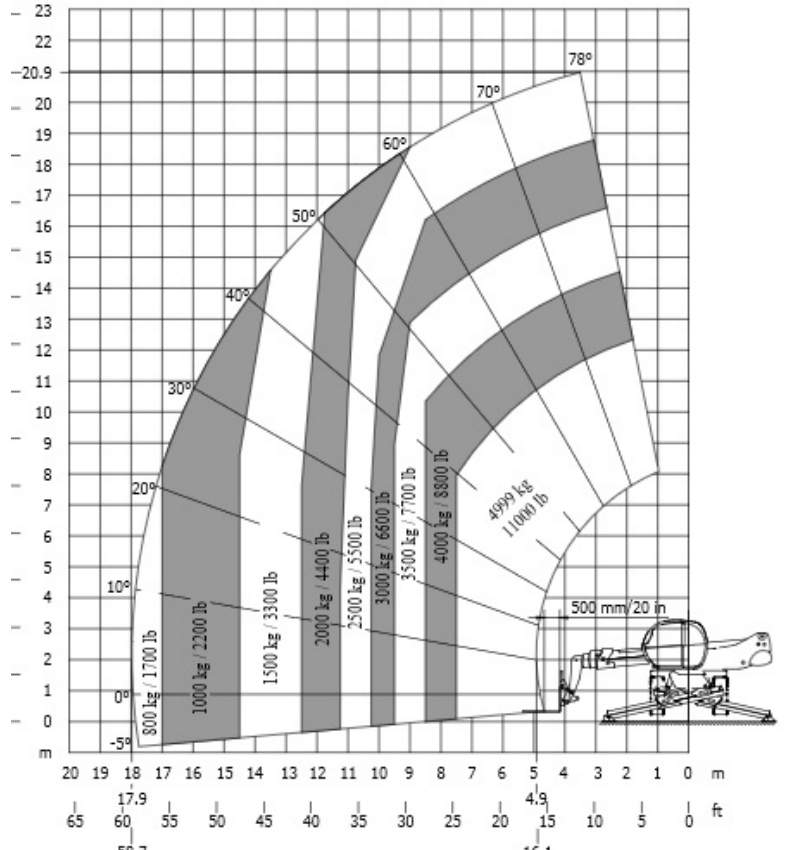
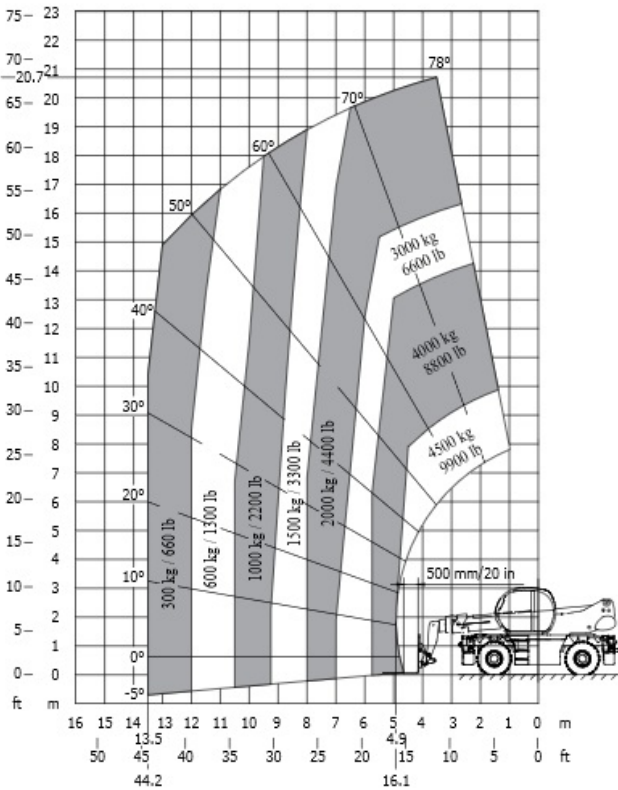



Mietpreise

	Stampfer	Rüttelplatten vorwärtslaufend		Rüttelplatten reversierbar					Grabenwalzen
	BT60	BVP10/36	BVP18/45	BPR25/50	BPR35/60	BPR55/65	BPR70/70	BPR100/80	BMP8500
Gewicht	65 kg	83 kg	91 kg	130 kg	195 kg	460 kg	595 kg	725 kg	1550 kg
Verdichtungskraft	17 kN	10 kN	18 kN	25 kN	35 kN	55 kN	70 kN	100 kN	80 kN
Arbeitsbreite	25 cm	36 cm	45 cm	50 cm	60 cm	65 cm	70 cm	80 cm	85 cm

Tagespreis

1-5 Miettage	40€	25€	30€	35€	40€	50€	60€	80€	100€
6-20 Miettage	30€	20€	25€	30€	30€	40€	50€	60€	80€
ab 20 Miettagen	20€	15€	15€	25€	20€	30€	40€	50€	60€

Vulkolanmatte: 10€/Tag

13 t Walzenzug Bomag BW 213

inkl. Sonderausstattung Variocontrol für optimale Verdichtung aller Tiefen und Terrameter incl. Drucker zur Messung der Bodenverdichtung.

Mietpreise

1-5 Tage: 220€ / Tag
 6-20 Tage: 200€ / Tag
 ab 20 Tage: 160€ / Tag

zzgl. Maschinenversicherung 10%/Tag
 und zzgl. 19% MwSt.

Verdichtungskraft	285 kN
Arbeitsbreite	2,13 m



Alle technischen Angaben sind gerundet. Maschinenversicherung: 10% des Mietpreises/Kalendertag.
 Alle Preise verstehen sich zzgl. Kraftstoff, Maschinenversicherung, Transport und 19% MwSt.



Atlas Copco Stromerzeuger QAX20

mit 12 m Lichtmast 6x1500W
Leistung: 20 kVA/16 kW



Tagespreis	
1-5 Miettage	120€
6-20 Miettage	80€
ab 20 Miettagen	50€

Leistung Kraftstoff	Stromerzeuger		
	3 kW Benzin	6 kW Benzin	12 kW Benzin
Tagespreis			
1-5 Miettage	30€	40€	50€
6-20 Miettage	25€	35€	45€
ab 20 Miettagen	20€	30€	40€



Dreiseitenkipper Raupendumper Yanmar C12R

Nutzlast	1200 kg
Durchfahrtsbreite	95 cm

Mietpreise	
1-5 Tage:	60€ / Tag
6-20 Tage:	50€ / Tag
ab 20 Tage:	40€ / Tag
zzgl. Maschinenversicherung 10%/Tag und zzgl. 19% MwSt.	

Alle technischen Angaben sind gerundet. Maschinenversicherung: 10% des Mietpreises/Kalendertag.
Alle Preise verstehen sich zzgl. Kraftstoff, Maschinenversicherung, Transport und 19% MwSt.

Anhänger Elektro Teleskop Arbeitsbühne Dino 120T

Antrieb:	230V
Korblast:	120 kg
Transportgewicht:	1300 kg
Abstützfläche:	4x4 m
Durchfahrts Höhe:	2,0 m
Durchfahrtsbreite:	1,75 m

Mietpreise

1–5 Tage:	100 € / Tag
6–20 Tage:	80 € / Tag
ab 20 Tage:	60 € / Tag

zzgl. Maschinenversicherung 10%/Tag
und zzgl. 19% MwSt.

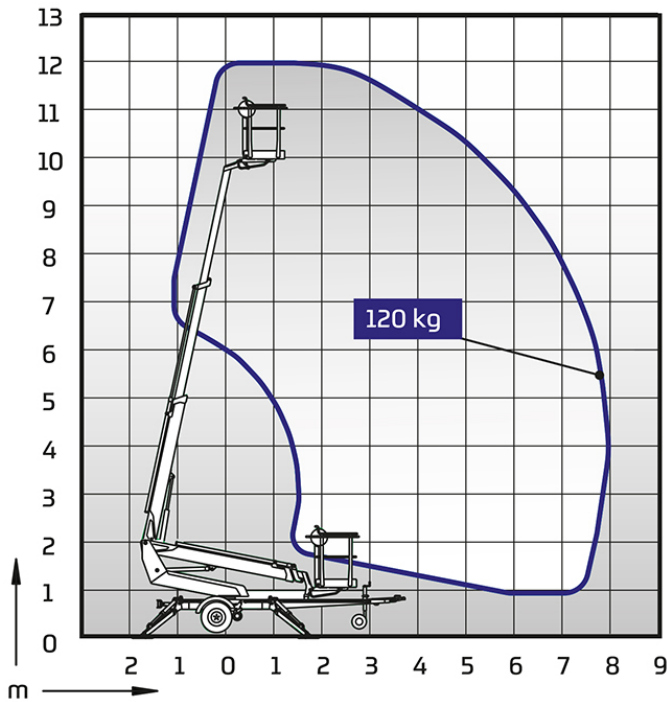

Raupen-Gelenk-Teleskop-Arbeitsbühne

CTE Traccess T135

Antrieb: Diesel oder 230V elektrisch
 Korblast: 200 kg
 Transportgewicht: 1600 kg mit Anhänger 2000 kg

Abstützfläche: 3x3 m
 Durchfahrtshöhe: 2,0 m
 Durchfahrtsbreite: 0,8 m

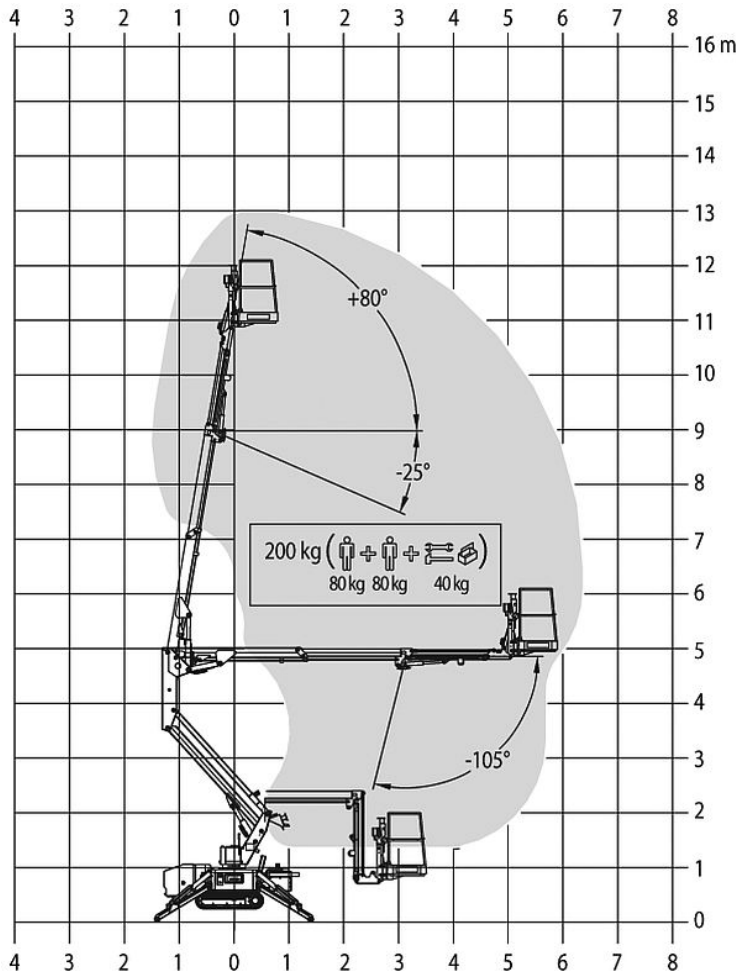

Mietpreise

1–5 Tage:	150 € / Tag
6–20 Tage:	130 € / Tag
ab 20 Tage:	100 € / Tag

zzgl. Maschinenversicherung 10%/Tag
 und zzgl. 19% MwSt.



Unser Service für SIE: Mietpreise **INKLUSIVE** Transportanhänger

Raupen-Gelenk-Teleskop-Arbeitsbühne Teupen LEO 21GT

Antrieb: Diesel oder 230V elektrisch
 Korblast: 250 kg
 Transportgewicht: 3000 kg mit Anhänger 3500 kg

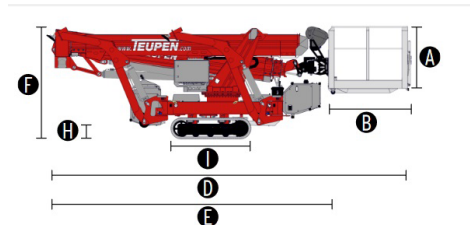
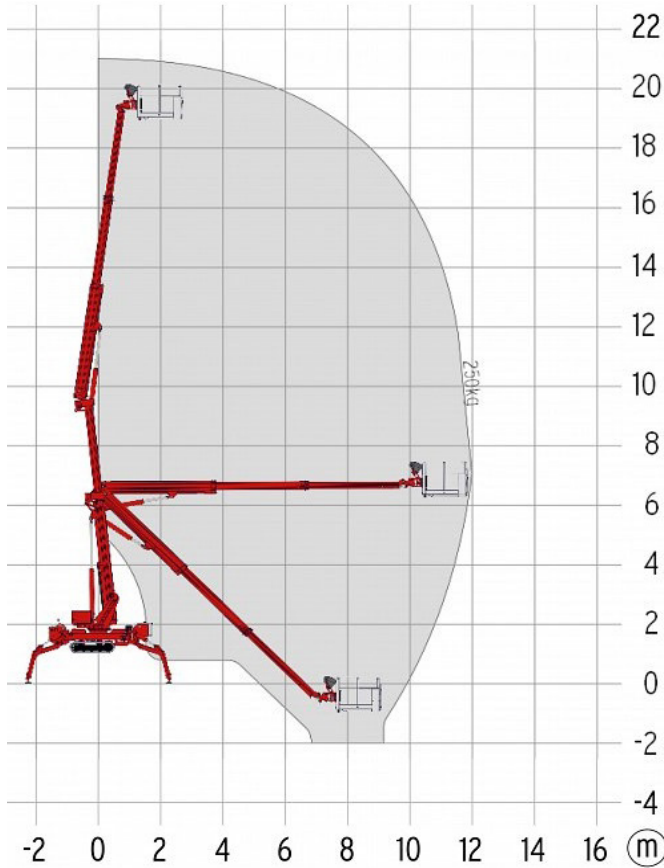

- A: 1,10m
- B: 1,40m
- C: 0,70m
- D: 6,40m
- E: 5,05m
- F: 1,97m
- G: 0,98m
- H: 0,44m
- I: 1,45m x 0,2m
- J: 4,70m
- K: 4,70m
- L: 6,30m
- M: 3,65m
- N: 2,65m

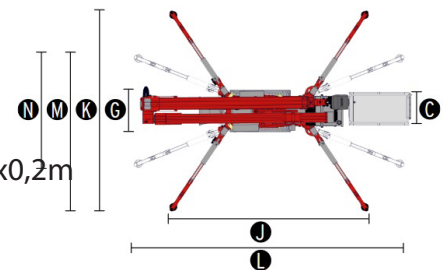

Incl. Funkfernbedienung

Auch als Kran einsetzbar.
Traglast: 300 kg

Mietpreise

1–5 Tage:	300 € / Tag
6–20 Tage:	250 € / Tag
ab 20 Tage:	200 € / Tag

zzgl. Maschinenversicherung 10% / Tag
und zzgl. 19% MwSt.

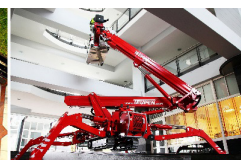

Unser Service für SIE: Mietpreise INKLUSIVE Transportanhänger



Diamant Schneidetechnik



	Trennschneider		Fugenschneider	Tischsäge
Blattdurchmesser	230 mm	350 mm	500 mm	350 mm
Schnitttiefe	80 mm	125 mm	190 mm	110 mm
Antrieb	230 V	Benzin	Benzin	230 V

Tagespreis

1-5 Miettage	20 €	40 €	50 €	40 €
6-20 Miettage	10 €	30 €	40 €	30 €
ab 20 Miettagen	5 €	20 €	30 €	20 €
Diamantabnutzung pro mm	9,50 €	19,50 €	25 €	19,50 €

Kernbohrgeräte



Bohrkronendurchmesser
Antrieb



52-250 mm
Elektrisch



110-350 mm
Benzin

Betonschleifgerät



250 mm
230V

Tagespreis

1-5 Miettage	80 €					100 €	80 €
6-20 Miettage	60 €					80 €	60 €
ab 20 Miettagen	50 €					50 €	50 €
Durchmesser (mm)	52-72 mm	82-102 mm	112-182 mm	202 - 250 mm	300 -350mm	Diamantabnutzung	
Diamantabnutzung							
Preis pro mm	10,50 €	13,50 €	18,50 €	35 €	45 €	35 €	

Sonstiges



Benzin
Hochdruckreiniger
unbeheizt



360V
beheizt



Abbruchhammer 230V
10 kg



30 kg



Betonrüttler
Benzin



Erdbohrer
15-35 cm

Tagespreis

1-5 Miettage	50 €	100 €	50 €	60 €	100 €	60 €
6-20 Miettage	40 €	80 €	40 €	50 €	80 €	40 €
ab 20 Miettagen	30 €	60 €	30 €	40 €	60 €	30 €

Preise zzgl. 19% MwSt

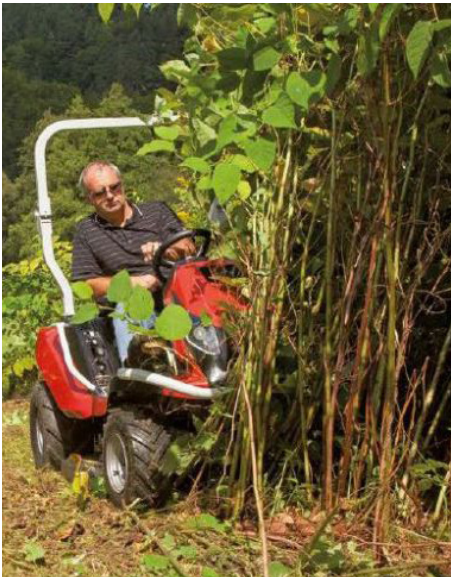

Mietpreise

1–5 Tage:	130 € / Tag
6–20 Tage:	80 € / Tag
ab 20 Tage:	60 € / Tag

zzgl. Maschinenversicherung 10%/Tag
und zzgl. 19% MwSt.

Hochgrasmäher

- Schnittbreite 92/110/132 cm, Allradantrieb, Differentialsperre
- mäht Gras und Gestrüpp bis zu 1,5m Höhe
- mit minimalem Kraftstoffverbrauch und enormer Flächenleistung
- geeignet auch für schweres Gelände

Für Kurzeinsätze: 40€ / Betriebsstunde

Unser Service für SIE: Mietpreise **INKLUSIVE** Transportanhänger



Herkules Raupenträger
MultiTec 23 RC 2.0 PRO
incl. Anbauschlegelmäher 110 cm

UVP: 49.999 Euro

Mietpreise

1–5 Tage:	400 € / Tag
6–20 Tage:	300 € / Tag
ab 20 Tage:	200 € / Tag

zzgl. Maschinenversicherung 10%/Tag
und zzgl. 19% MwSt.



Unser Service für SIE: Mietpreise **INKLUSIVE** Transportanhänger

Alle technischen Angaben sind gerundet. Maschinenversicherung: 10% des Mietpreises/Kalendertag.
Alle Preise verstehen sich zzgl. Kraftstoff, Maschinenversicherung, Transport und 19% MwSt.



Mietpreise Gartengeräte

Vertikutierer

pro Tag
pro Stunde

50,00 Euro
20,00 Euro



Motorhacke

pro Tag
pro Stunde

50,00 Euro
30,00 Euro



Rasenwalze

pro Tag
pro Stunde

20,00 Euro
10,00 Euro



Bodenfräse Agria 3000



Mietpreise

1–5 Tage: 100 € / Tag

6–20 Tage: 80 € / Tag

ab 20 Tage: 60 € / Tag

zzgl. Maschinenversicherung 10%/Tag
und zzgl. 19% MwSt.

HT Baumaschinen

GmbH

Vermietung • Vertrieb • Reparatur

Aubstädter Str. 20 • 97631 Bad Königshofen



HT Baumaschinen GmbH
Aubstädter Straße 20
97631 Bad Königshofen
Deutschland

Zentrale	09761 /395 678 - 0
Mietpark	09761 /395 678 - 1
Bestellung	09761 /395 678 - 2
Technischer Service	09761 /395 678 - 3
Verkauf	09761 /395 678 - 4

info@ht-baumaschinen.de
mietpark@ht-baumaschinen.de
bestellung@ht-baumaschinen.de
technik@ht-baumaschinen.de
verkauf@ht-baumaschinen.de

www.ht-baumaschinen.de • www.baumateile.de